

GEBERIT INSTALLATION SYSTEMS

Systems for Wall-Hung Toilets, Pre-Wall, 2x6 Installation

Geberit Duofix Carrier, Omega 2x6 Installation

Model No.	Description	List Price \$
111.012.00.1	Carrier frame with 1.6/0.8 GPF Omega Concealed Tank, pre-wall installations	655.00
111.018.00.1	Carrier frame with 1.28/0.8 GPF Omega Concealed Tank, pre-wall installation	655.00

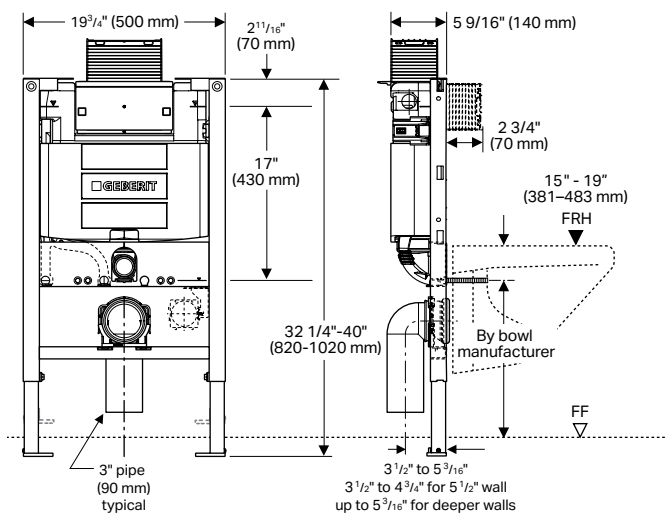



NOTES:

1. Concealed tank shipped dual-flush ready
2. Carrier for 2-hole washdown style wall-hung toilet fixtures only
3. Refer to geberit.us for latest list of code approved compatible toilet fixtures, including certified WaterSense® combinations

Note: For System Accessories see pages 26-28.











Dual-Flush Actuators, Omega 2x6 Installation

Style	Material	Finish	Model No.	List Price \$	
	Plastic	Polished Chrome/Matte Chrome/Polished Chrome*	115.085.KH.1	308.00	
		White/Polished Chrome/White*	115.085.KJ.1	227.00	
		White/Gold-Plated/White*	115.085.KK.1	250.00	
		Black/Polished Chrome/Black	115.085.KM.1	250.00	
		Matte Chrome/Polished Chrome/Matte Chrome*	115.085.JQ.1	308.00	
	Plastic	Polished Chrome/Matte Chrome/Polished Chrome***	115.080.KH.1	308.00	
		White/Polished Chrome/White***	115.080.KJ.1	227.00	
		White/Gold-Plated/White***	115.080.KK.1	250.00	
		Black/Polished Chrome/Black***	115.080.KM.1	250.00	
		Matte Chrome/Polished Chrome/Matte Chrome***	115.080.JQ.1	308.00	
	Zinc	Brushed Chrome	115.081.GH.1	897.00	
		Lava Glass NEW!	115.081.JK.1	897.00	
		Grey Sand Glass NEW!	115.081.JL.1	897.00	
		White Glass/Aluminum	115.081.SL.1	897.00	
	Glass	Black Glass/Aluminum	115.081.SJ.1	897.00	
		Zinc	Cover frame (when needed) Brushed Chrome	115.086.GH.1	197.00
			Cover frame (when needed) Polished Chrome	115.086.21.1	197.00



* Finishes follow this pattern = Plate-Ring-Button
 ** Finishes follow this pattern = Frame-Button
 *** Finishes follow this pattern = Frame-Button Edge Trim-Button
 † Note: For tile, stone or other hard surfaced walls only!
 ‡ Not intended to be sold in California with 1.6 GPF units

The information contained in this document is subject to change without notice.

Dual-Flush Buttons for Concealed Installations, Omega 2x6 Installation

Style	Material	Finish	Model No.	List Price \$	
Type 01 	Plastic	Alpine White	116.042.11.1	139.00	
		Polished Chrome	116.042.21.1	181.00	
	Plastic	Alpine White 	116.044.11.1	139.00	
Type 10 		Matte Chrome-Polished Chrome**	116.055.KH.1	198.00	
		Polished Chrome-White**	116.055.KJ.1	181.00	
Type 70 	Stainless	Brushed Stainless Steel 	115.084.FW.1	923.00	
		Glass	Lava Glass NEW!	115.084.JK.1	785.00
			Grey Sand Glass NEW!	115.084.JL.1	785.00
			White Glass 	115.084.SL.1	785.00
			Black Glass 	115.084.SJ.1	785.00
Rectangle 	Plastic	Polished Chrome-Matte Chrome**	116.051.KA.1	181.00	
		Black-Chrome NEW!	116.051.KV.1	181.00	
	Zinc	Brushed Chrome	116.051.GH.1	313.00	
	Plastic	Polished Chrome 	116.052.21.1	181.00	



Dual-Flush Buttons for Furniture Installations, Omega 2x6 Installation

Type 01 	Plastic	Alpine White	116.050.11.1	139.00
		Polished Chrome	116.050.21.1	181.00
		Matte Chrome	116.050.46.1	181.00
Type 10 	Plastic	Matte Chrome-Polished Chrome**	116.057.KH.1	198.00
		Polished Chrome-White**	116.057.KJ.1	181.00

Single-Flush Buttons for Concealed Installations, Omega 2x6 Installation

Type 01† 	Plastic	Alpine White	116.040.11.1	119.00
		Polished Chrome	116.040.21.1	139.00

Extension Hoses for Flush Button Installations

(For Flush Buttons located beyond 6' from carrier)			
	Double pneumatic hose for dual flush 78.74" (2 m) (Blue/Clear for Type 01/Type 10/Rectangle)	240.575.00.1	10.00
	Double pneumatic hose, 78.74" (2 m), dual-flush (Green/Clear for Type 70)	243.297.00.1	10.00
	Pneumatic hose 137.80" (3.5 m) for single flush	256.000.00.1	9.00

Cover Plates for Omega Concealed Tank Pre-wall, 2x6 Installation for use with Flush Buttons

	Glass	White	115.082.SL.1	212.00
	Plastic	Customizable	115.082.00.1	243.00

Surface Even Cover Plates for Omega Concealed Tank, 2x6 Installation, for use with Flush Buttons

	Plastic	Customizable + rough-in kit†	115.087.00.1	243.00
		Customizable with frame + rough-in kit†	115.088.00.1	306.00

Note: Includes required accessory kit.

Products marked with  comply with the American Disabilities Act (ADA) when installed per the requirements of the latest ADA Accessibility Guidelines (ADAAG) and/or ICC/ANSI A117.1.

Geberit Duofix Carrier 111.012.00.1 and 111.018.00.1, Omega 2x6 Installation

Item	Model No.	Description	List Price \$	Item	Model No.	Description	List Price \$
1	240.269.00.1	Angle stop valve to concealed tank (blue handle)	23.00	14.1	217.713.46.1	Cover caps with leveling washer, plastic, Matte Chrome	8.00
1.1	240.298.00.1	Spindle to angle stop valve	18.00	14.2	119.668.00.1	Seal for supply inlet tube, EPDM	4.00
1.2	241.857.00.1	Counter nut, plastic	6.00	14.3	152.424.00.1	Seal for toilet outlet connector, EPDM	6.00
1.3	240.347.00.1	Handle for angle stop valve (blue)	6.00	15	242.314.00.1	Materials for Concealed Carrier and Tank installation	66.00
2	240.629.00.1	Reinforced braided hose for Geberit Kappa and Omega Concealed Tank	23.00	16	366.061.16.1	HDPE waste fitting outlet bend, 1 x 90° bend with socket for Ø3.50" (Ø90 mm) push fit piping and Ø3.50" (Ø90 mm) outlet	25.00
2.1	240.922.00.1	Set of seals for RFB hose	5.00	16.1	387.282.00.1	Seal for outlet bends, EPDM	6.00
3	243.088.00.1	Mounting bracket for filling valve	7.00	17	366.820.92.1	Protection plug, plastic	5.00
4	241.469.00.1	Fill valve Type 380	32.00	18	240.189.00.1	Threaded rod for wall-mounted toilet or bidet installation	6.00
4.1	240.771.00.1	Seal kit for filling valve Type 380	12.00	19	242.886.00.1	Conduit pipe for shower toilet water supply with Sigma Concealed Tank 2x6, Omega Concealed Tank or Kappa Concealed Tank (from 2013 on)	14.00
5	243.090.00.1	Protection plate	65.00	20	111.892.00.1	Frame mounting screws for steel stud construction, galvanized, self-tapping	7.00
6	243.091.00.1	Support block	20.00	21	—	Flexible coupling FERNCO 3005-33	—
7	243.092.00.1	Mud guard protection housing	30.00	22	244.125.00.1	Foot plate set	17.00
8	243.093.00.1	Insertion plate	9.00	23A	245.377.00.1	1.6/0.8 GPF dual flush valve for Omega Tanks	42.00
9.1	241.167.00.1	Yoke set for flush valves	12.00	23B	245.372.00.1	1.28/0.8 GPF dual flush valve for Omega Tanks	42.00
9.2	816.418.00.1	Geberit flat gasket for flush valve	4.00	23.1	244.844.00.1	Handle set	14.00
10.2	241.868.00.1	U-cup seal for valve basket after 2008	4.00	23.2	244.244.00.1	Flat gasket seal	4.00
11	362.771.00.1	Seal for concealed flush pipe, EPDM	4.00	23.3	241.868.00.1	U-cup seal for valve basket	4.00
12	362.796.92.1	Protection plug, plastic	7.00				
13	242.012.00.1	Outlet pipe bracket (complete)	7.00				
14	152.404.46.1	Connector set with mounting hardware (bowl installation kit), HDPE, Matte Chrome cover caps	50.00				
14	152.404.11.1	Connector set with mounting hardware (bowl installation kit), HDPE, Matte White cover caps (accessory only)	50.00				

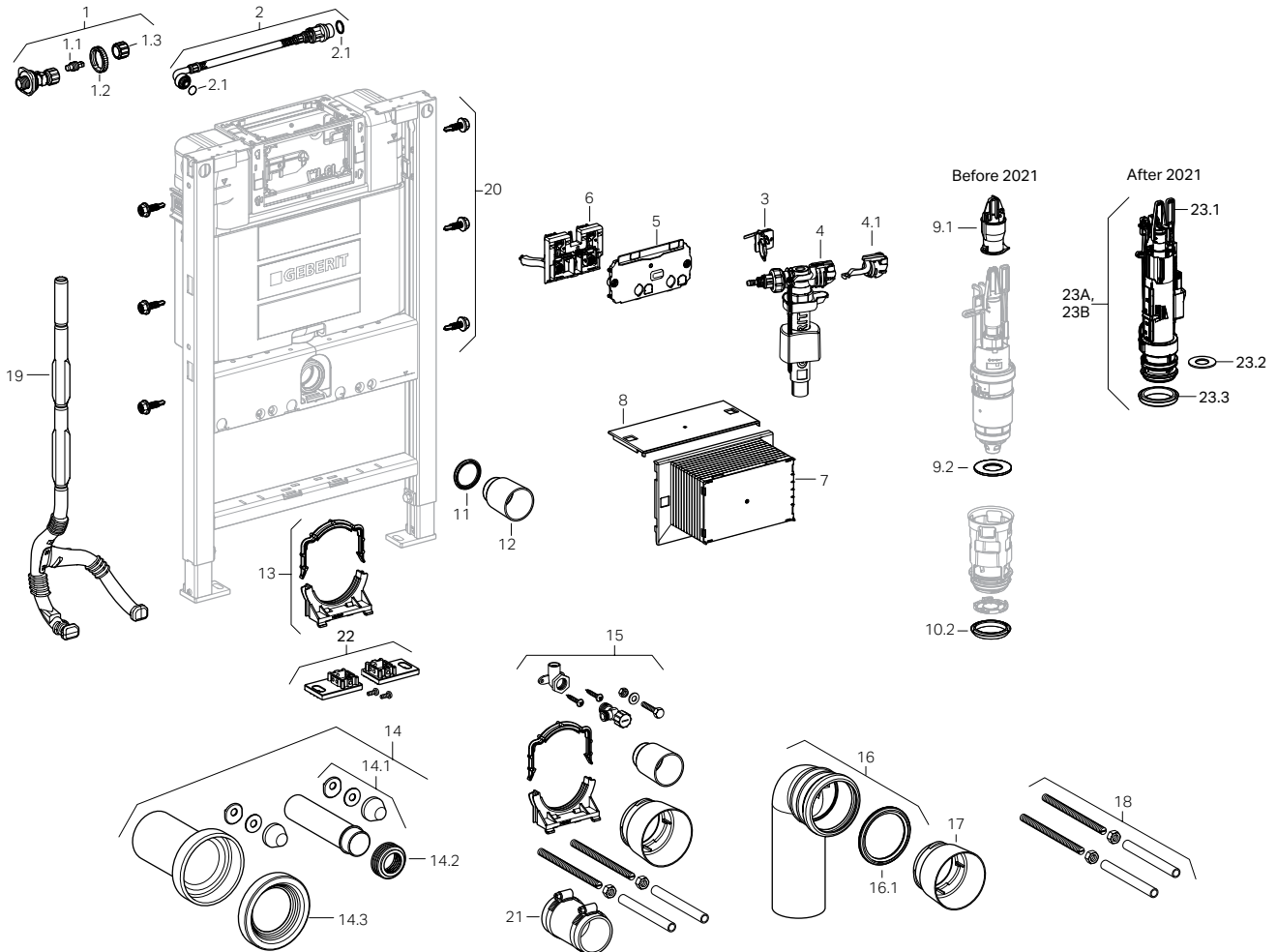

The information contained in this document is subject to change without notice.

GEBERIT SYSTEM ACCESSORIES

Geberit Optional and Required Accessories for Installation

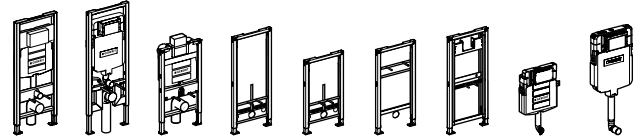

Description	Model Number	List Price \$	111.335	111.798	111.012						109.304		
			111.902	111.597	111.018	111.520	111.524	111.490	111.625	109.307	109.797		

OPTIONAL Connection Sets and Accessories for Finished Walls up to 3.5" (9cm) Thick

	PE syphon trap with horizontal outlet and seal; Ø1.96" (Ø50 mm) outlet	152.950.11.1	40.00										✓		
	PE syphon trap with vertical outlet and seal; Ø1.97" (Ø50 mm) outlet	152.951.11.1	40.00										✓		
	Acoustic insulation set for wall-hung toilets and bidets	156.050.00.1	21.00	✓	✓	✓	✓	✓							
	Cover caps with leveling washer, plastic, Alpine White	217.713.11.1	10.00	✓	✓	✓	✓	✓	✓						
	HDPE connection set with 1" (2.5 cm) offset and mounting hardware (bowl installation kit); with socket for Ø3.50" (Ø90 mm) push fit piping and Ø55 supply inlet; Matte Chrome cover caps	405.116.00.1	252.00	✓	✓	✓								✓	✓

REQUIRED Connection Sets and Accessories for Finished Walls 3.5" - 7.0" (9-18cm) Thick

	HDPE Connector set for extended installation and mounting hardware (bowl installation kit), with socket for Ø3.50" (Ø90 mm) push fit piping and Ø2.16" (Ø55 mm) supply inlet; Matte Chrome cover caps	152.438.46.1	63.00	✓	✓	✓								✓	✓
	Extension set for actuator plates for Sigma Concealed Tanks 2x6 and 2x4, Kappa and Omega Concealed Tanks	240.938.00.1	28.00	✓	✓	✓								✓	✓
	Mud guard protection housing for Sigma Concealed Tanks 2x6 and 2x4, plastic, 4 inch (10 cm)	241.826.00.1	15.00	✓	✓									✓	✓
	Mud guard protection housing and extension set for urinal carrier	241.930.00.1	22.00										✓		
	Mounting rod M12 x 10" long. Not supplied.	M12 x 10"	—	✓	✓	✓	✓	✓							
	Mounting rod M10 x 10" long. Not supplied.	M10 x 10"	—							✓					
	Mounting rod M8 x 10" long. Not supplied.	M8 x 10"	—									✓			

The information contained in this document is subject to change without notice.

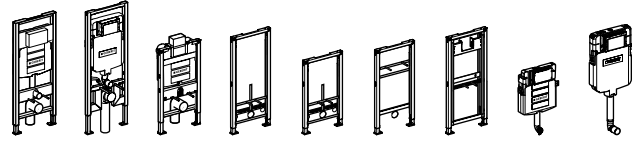

Description	Model Number	List Price \$	111.335	111.798	111.012						109.304		
			111.902	111.597	111.018	111.520	111.524	111.490	111.625	109.307	109.797		

OPTIONAL Installation Accessories for Bidet Seats

	Water supply hose for bidet seat for Kappa and Omega Concealed Tank pre-wall. For adding bidet seat to an installed carrier. For complete installation, must order with 249.801.00.1.	240.839.00.1	72.00			✓									
	Water supply hose for bidet seat for 111.597.00.1 and 111.798.00.1 carrier with Sigma Concealed Tank 2x4. For adding bidet seat to an installed carrier. For complete installation, must order with 249.801.00.1.	243.173.00.1	54.00		✓										
	Water supply hose for bidet seat add-on after finished installation of Sigma 2x6 and 2x4, Kappa and Omega Concealed Tanks.	249.801.00.1	130.00	✓	✓	✓									

OPTIONAL Installation Accessories for Geberit Duofix Carrier Frames

	Frame to wall anchoring for 5.125"-7.875" (13-20 cm) thick unfinished pre-wall	111.013.00.1	27.00		✓										
	Frame to wall anchoring for 5.125"-7.875" (13-20 cm) thick unfinished pre-wall	111.815.00.1	39.00	✓		✓	✓	✓	✓	✓	✓				
	Frame to wall anchoring for 5.125"-7.875" (13-20 cm) thick unfinished pre-wall corner installations	111.835.00.1	39.00	✓	✓	✓	✓	✓	✓	✓	✓				
	Support brackets for wall-hung toilets with small contact surface (thin profiles)	111.847.00.1	54.00	✓		✓									
	Fire protection set for Sigma Concealed Tank 90 min. fire resistance to DIN EN 1364-1:1999-10	111.863.00.1	586.00	✓											
	Frame to wall anchoring where foot installations into floor are not allowed for 5.125"-9.50" (13-24 cm)	111.064.00.1	74.00	✓	✓	✓	✓	✓	✓	✓	✓				
	Fastening set for sinks with 14.9"-22.8" (38-58 cm) mounting centers	111.868.00.1	128.00							✓					
	Frame to stud fastening set for extended stud spacing from 19.75"-25.56" (50-65 cm)	111.869.00.1	39.00	✓	✓	✓	✓	✓	✓	✓	✓				
	Frame to wall anchoring extensions for 7.875"-15.75" (20-40 cm) thick (unfinished pre-wall)	111.887.00.1	17.00	✓	✓	✓	✓	✓	✓	✓	✓				
	Crossbar for inlet 1/2" thread	242.042.00.1	121.00									✓			
	Retrofit adapter for inlet, 1/2" thread	242.309.00.1	121.00									✓			
	Elbow supply fitting set, Gun Metal	465.034.00.2	42.00				✓	✓	✓						

The information contained in this document is subject to change without notice.

GEBERIT SYSTEM ACCESSORIES

Geberit Optional and Required Accessories for Installation

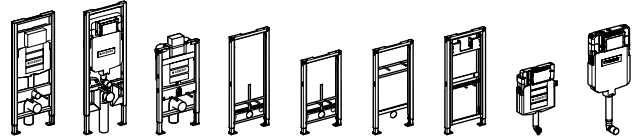

Description	Model Number	List Price \$	111.335	111.798	111.012	111.520	111.524	111.490	111.625	109.304	109.307	109.797
			111.902	111.597	111.018					111.625		

OPTIONAL Installation Waste Fitting Accessories

	PP connector set with bend for floor-mount toilets with mounting hardware, 1 x 90° bends with socket for Ø4.375" (Ø110 mm) push fit piping for Ø3.82"-4.21" (Ø97-107 mm) male connection and expansion to Ø4.375" (Ø110 mm) outlet	152.647.00.1	128.00								✓ (For A or B discharge. See below)	✓
	HDPE waste fitting outlet bend, 1 x 90° bend with socket for Ø3.50" (Ø90 mm) push fit piping and Ø3.50" (Ø90 mm) outlet	366.061.16.1	25.00								✓ (For A discharge. See below)	✓
	HDPE straight connector with socket for Ø3.50" (Ø90 mm) push fit piping and Ø3.50" (Ø90 mm) outlet x 12" (31 cm) long	366.887.16.1	39.00	✓	✓	✓					✓ (For A discharge. See below)	✓
	HDPE connector with offset for LH horizontal drain connections (as viewed from sitting position), 1 x 90° bend with socket for Ø3.50" (Ø90 mm) push fit piping, with 45° offset and Ø3.50" (Ø90 mm) outlet for 5.5" (13.97 cm) minimum walls only.	366.913.16.1	83.00	✓	✓	✓					✓ (For A discharge. See below)	✓
	HDPE connector with offset for RH horizontal drain connections (as viewed from sitting position), 1 x 90° bend with socket for Ø3.50" (Ø90 mm) push fit piping, with 45° offset and Ø3.50" (Ø90 mm) outlet for 5.5" (13.97 cm) minimum walls only.	366.914.16.1	83.00	✓	✓	✓					✓ (For A discharge. See below)	✓
	Cast iron fitting; 90° 3.5" (90 mm) inlet, 3" outlet, 2" NPTF heel outlet	367.072.18.1	251.00	✓	✓	✓					✓ (For A discharge. See below)	✓
	HDPE "Back-to-back" connector for horizontal drain connections; 2 x 90° bends with sockets for Ø3.50" (Ø90 mm) push fit piping, with 45° offset and expansion to Ø4.375" (Ø110 mm) outlet for 10.75" (27.31 cm) minimum walls only.	367.485.16.1	170.00	✓	✓	✓					✓ (For A or B discharge. See below)	✓
	HDPE "Back-to-back" connector for vertical drain connections; 2 x 90° bends with sockets for Ø3.50" (Ø90 mm) push fit piping and expansion to Ø4.375" (Ø110 mm) outlet for 10.75" (27.31 cm) minimum walls only.	367.923.16.1	166.00	✓	✓	✓					✓ (For A or B discharge. See below)	✓

Note: Any of these fittings in combination with Geberit installation systems are cUPC and IPC listed.

Waste Fitting Discharge Configurations for Floor Mount Back Outlet Toilets

Note: Mounting collar/clamp by installer

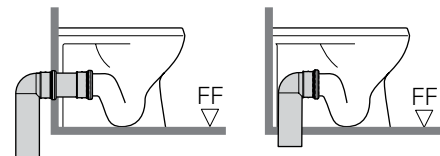

A. Floor-Mount Rear Discharge into Wall

B. Floor-Mount Rear Discharge into Floor

The information contained in this document is subject to change without notice.